

Important! This quick reference guide does not replace the user manual which can be downloaded at www.humancaregroup.com.
Read all instructions before use!

Components

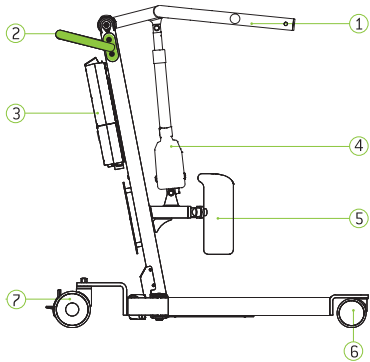

- | | |
|-----------------------------|-----------------------------|
| 1. Lift Arm | 6. Front Wheels |
| 2. Push Handle | 7. Rear Wheel (with brake) |
| 3. Battery/Control Box Unit | 8. Hand Control (not shown) |
| 4. Actuator | 9. Footplate (not shown) |
| 5. Shin Pads | |

Hand Control Functions

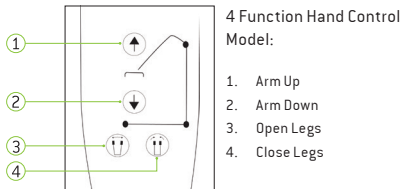

Control Box

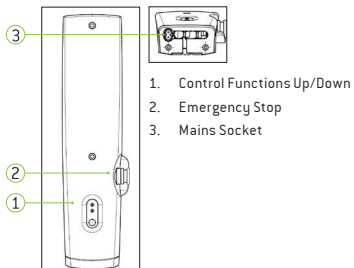

Important! This mobile lift has been designed and tested for indoor use with one patient at a time. Do not use if you do not fully understand the instructions in the user manual.

Charging the Battery

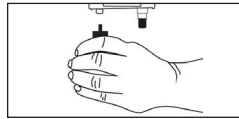

1 Connect the power cord to the mains to charge the battery.

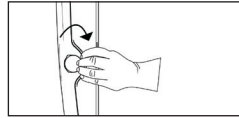

Charge minimum 8 hours before first use!
2. To commence charge, disengage the emergency stop located on the side of the control box by turning clockwise.

Important! It is recommended that the battery be charged at minimum once per week (depending on use). Regular charging prevents problems and extends the life of the battery.

Checklists

Checklist Prior to Each Use

- ✓ Battery is fully charged
- ✓ Sling shows no signs of wear
- ✓ Plastic components i.e. clips are not cracked, damaged or worn
- ✓ Electrical lift and handset functions checked and working
- ✓ Brakes hold position when locked

Refer to the User Manual for Annual Checklist

Checklist After Each Use

- ✓ Clean according to cleaning instructions.
- ✓ Press the emergency button when the lift is not in use to preserve battery life.

Model: 20000170
Human Care HC AB. All Rights Reserved.



Safe Lifting Techniques

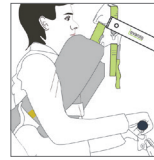

Before use, ensure that all clips are securely attached and that the sling is adjusted to the same length on both sides. Never place the patient on the belt as a seat! The belt is designed to support the back under the arms.



Explain, if necessary, to the patient about the lift. Check during the lift that the patient is comfortable. Look for non-verbal signs of discomfort.

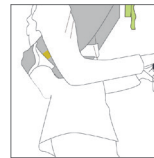

Make sure the patient will not slide out of the belt. The belt should comfortably surround the patient being lifted.

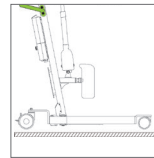

The Levanto must only be used on a level surface clear of obstacles. Never use on stairs, escalators or an incline/decline such as up or down a hill.

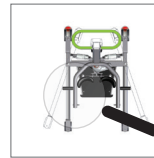

Inspect the Levanto and any slings used prior to each use to ensure that it is good working order. Do not use if any parts show signs of wear or damage.



There is always a risk when transferring a patient. Evaluate patient abilities prior to performing any lifts. If required, have two caregivers present.

Never leave a patient unattended in the lift!

Usage



Maximum weight capacity
352.7lb/160kg



Important! Only patients with enough muscle strength to bear some of their weight should use this product. They should have enough strength in their arms and shoulders to keep the sling in place. They must be capable of understanding that they are being lifted.

General Care

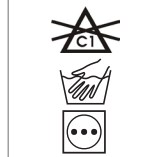

Use a clean, dry cloth or a cloth moistened with clean water and mild detergent to clean. Do not autoclave or pressure clean. Most phenolic or quaternary type disinfectants can be used diluted in accordance with manufacturer recommendations.



Important! Complete care instructions can be found in the user manual.

Product Information

SERIAL NUMBER

Using the lift

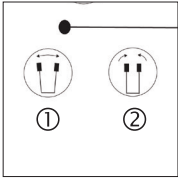

Spreading the Base

The base may be adjusted by using the hand control. To increase leg width, press on the open button ① until desired spread is achieved. To decrease leg width, press the close button ②.



Adjusting the Shin Pads

Adjust the shin pad so that the top is placed 2cm/0.8" (approximately 2 fingers) below the knee to keep the patella free for movement. The front of the leg should touch the pad without space. **Warning! Make sure to stop the shin pads before they lower onto a patient's feet.**



Important! Ensure the emergency stop button is engaged prior to any adjustment.

Removable Footplate

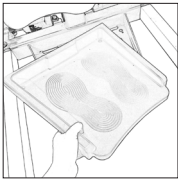

The footplate is removable for hygiene control. Lift up and clean with a household cleaning agent or an alcohol-based detergent with a maximum of 5% alcohol. It may be disinfected with a 1:10 dilution of household bleach (5.25% sodium hypochlorite).

Emergency Lowering

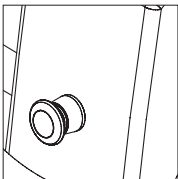

The emergency on/off push button will interrupt and stop the lifting process. For emergency lowering due to hand control/button failure or power outage, the Levanto is equipped with a manual emergency lowering system.

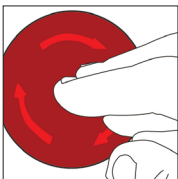

To activate, press the red button on the side of the control box.



After emergency lowering is used, the lift must be serviced by an authorized technician.

Moving the Patient

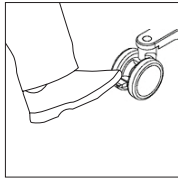

Unlock the rear casters and using the caregiver handles, move the patient as required. **⚠** Ensure the patient is securely held in position during the entire move.

Raising and Lowering the Patient

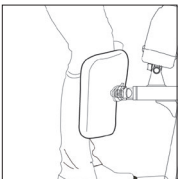

Bring the Levanto up to the patient, spreading the base as required. Place the patient's feet on the footplate and lock the rear casters. Adjust the shin pads so that the top of the shin pads are approximately 2cm/0.8" below the patient's knees and the front of the leg touches the shin pad without space.

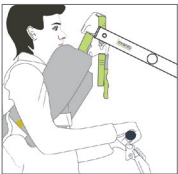

Place the sling around the patient's back and pass the ends under the patient's arms. Fit belt and secure. Attach clips and lift patient approximately 2.5cm/1" to ensure security.



At the beginning of the lifting process, keep a hand on the sling to ensure it remains in the correct position. Lift only from a safe, seated position. If possible, have the patient grasp the patient handles with both hands.

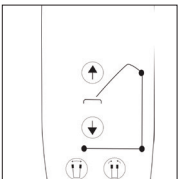

Press the arrow up button to raise the patient. Alternatively, press the arrow down button to lower the patient.



Ensure the brake is NOT engaged seating patient. Ensure that if lowering patient into a wheelchair, the wheelchair brake is engaged. Only when the patient is fully seated on a firm surface should the shin pad and sling be removed.

Maintenance

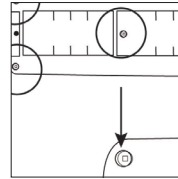

Changing the Battery

The battery in this device is located in the module along with the control box. To replace the battery, you must remove the control box from the frame and on the back side, unscrew and remove the 7 Torx screws.

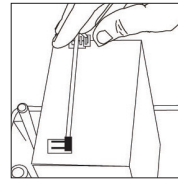

Once opened, disconnect the battery connectors and insert the new batteries in the same direction with the connectors at the top [Note: + = red, - = black]. Take care not to bend these connectors.

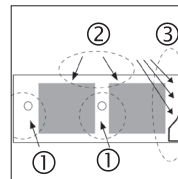

⚠ Disconnect the mains!

- ① Do not cover the holes.
- ② Ensure no wires are squeezed or caught when reinstalling the cover.
- ③ Ensure the silicone string is in place and properly fitted before reinstalling the cover.



Important! Replace the tamper proof seal after replacing the battery. Depress the emergency stop when the lift is not in use to prevent drainage.



CAUTION

The Levanto battery is protected by a silicone string. This must not be damaged or modified in any way as it will allow penetration of battery gas into the electronics component with risk of explosion. Never use this lift if the seal is damaged in any way!

Troubleshooting

Maintenance and service must only be carried out by qualified and authorized personnel. To ensure trouble-free operation, use only Human Care parts.

The lift will not operate up/down function.	Check that the emergency stop is off. Check that the battery is sufficiently charged.
The lift will not operate the open/close function.	Check that the emergency stop is off. Check that the battery is sufficiently charged. Ensure nothing is blocking the path.
The hand control will not work.	Check that the plug is properly inserted into the control box. Check the control box functions - if functioning replace hand control.
Shin pads are not secure.	Replace shin pads.
The lift will not start.	Check that the plugs are properly inserted.
The battery is not charging.	Release the emergency stop button.

Contact your local Human Care office for additional troubleshooting not listed above.

Maintenance Record

LAST SERVICE DATE

PERFORMED BY